

Type : 2EL071M2B-FA-A0-000**Date** : 01.01.2023

Power [kW]	: 0.55	Efficiency Class	: IE2
Input Voltage [V]	: 400	Duty Cycle	: S1
Connection Type [Δ / Y]	: Y	Service Factor	: 1.15
Frequency [Hz]	: 50	Frame Size	: 071M
Pole Number	: 2	Weight [kg]	: 6.20
Nominal Speed [rpm]	: 2790	Insulation Class	: F [155°C]
Nominal Current [A]	: 1.27	Temperature Rise	: B [80°K]
Nominal Moment [Nm]	: 1.88	Protection Class	: IP55
Nominal Efficiency [η]	: 75.8	Vibration Severity Grade	: A
Power Factor [$\cos\phi$]	: 0.82	Method of Cooling	: IC411 (TEFC)
Locked Rotor Current [I_a/I_n]	: 5.0	Direction of Rotation	: Bidirectional
Locked Rotor Torque [M_a/M_n]	: 2.8	Balance	: Half Key
Breakdown Torque [M_k/M_n]	: 2.9	Motor Thermal Protection	: --
Motor Color	: RAL 7031	Altitude Above Sea Level	: 1000m
Ambient Temperature	: -15°C / +40°C	Sound Pressure Level [dBA]	: 54

ELECTRICAL DATA

Δ / Y	U [V]	f [Hz]	P [kW]	n [rpm]	I [A]	η [%100]	η [%75]	η [%50]	Cos ϕ	Cl
Δ	230	50	0.55	2790	2.20	75.8	77.0	76.0	0.82	IE2
Y	400	50	0.55	2790	1.27	75.8	77.0	76.0	0.82	IE2
Y	460	60	0.55	3420	1.13	77.3	78.1	75.3	0.79	IE2
Y	460	60	0.64	3400	1.26	77.5	78.3	75.5	0.82	IE2

MECHANICAL DATA

Moment of Inertia [kgm ²]	: 0.00037
Bearing [DS / NS]	: 6202ZZ / 6202ZZ
Frame Material	: Aluminum
Flange Type / Material	: B5 / Aluminum
Cooling Fan Material	: Plastic
End Shield Material	: Aluminum

TERMINAL BOX

Terminal Box Material	: Aluminum
Terminal Box Position	: Top
Terminal Box Cable Entry	: M20x1.5
Terminal Box Blind Cap	: M16x1.5
Contact Screw Thread	: M4

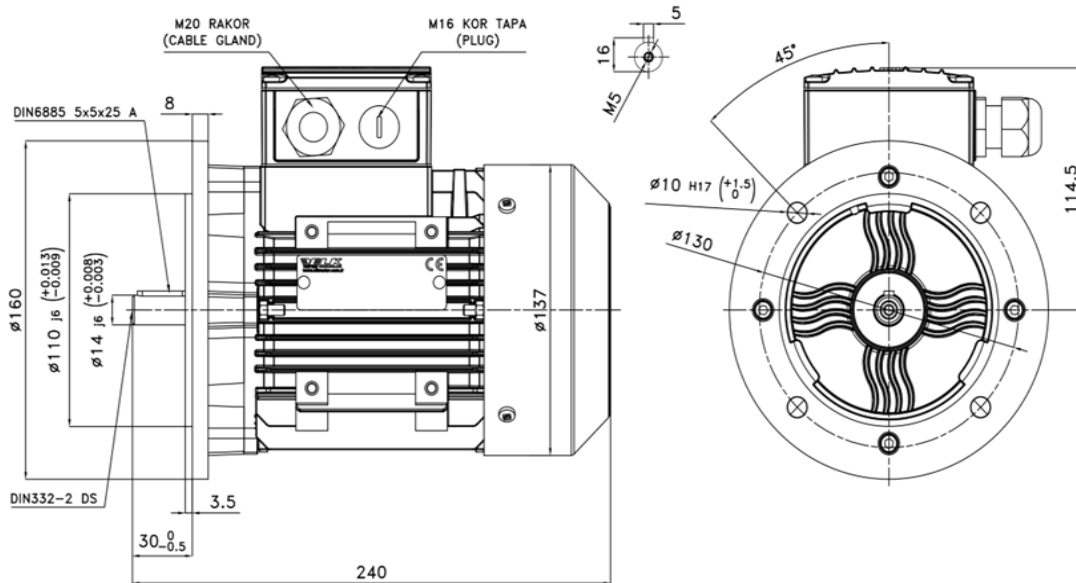
MECHANICAL DIMENSIONS

Manufactured and tested in accordance with IEC 60034

*Technical data are subject to change! There may be discrepancies between calculated and rating plate values.

*ELK Motor has right to change all the data without prior notice.

FR.AG.010 REV.NO: 04 REV.DATE: 01.01.2023



ELK MOTOR SAN. ve TİC. A.Ş.
www.elkmotor.com.tr
+90 (282) 726 92 94

TECHNICAL DATASHEET ACCORDING TO COMMISSION REGULATION (EU) 2019/1781 THREE PHASE INDUCTION MOTOR - SQUIRREL CAGE

Type : 2EL071M2B-FA-A0-000

Date : 01.01.2023

NAMEPLATE DATA

Power [kW]	: 0.55	Nominal Speed [rpm]	: 2790
Nominal Voltage [V]	: 400	Nominal Current [A]	: 1.27
Connection Type [Δ / Y]	: Y	Nominal Moment [Nm]	: 1.88
Nominal Frequency [Hz]	: 50	Nominal Efficiency [η %]	: 75.8

THE POWER LOSSES AT SEVEN OPERATING POINTS ACCORDING TO COMMISSION REGULATION (EU) 2019/1781

Operating Point Number	Speed n/n_N [%]	Torque T/T_N [%]	Relative Power Losses P_L/P_N [%]	Efficiency η [%]
P ₁	90	100	28.8	75.7
P ₂	50	100	31.6	61.3
P ₃	25	100	30.7	44.9
P ₄	90	50	14.1	76.2
P ₅	50	50	11.2	69.1
P ₆	50	25	9.7	56.4
P ₇	25	25	5.7	52.1

MAP OF RELATIVE POWER LOSSES P_L/P_N [%]

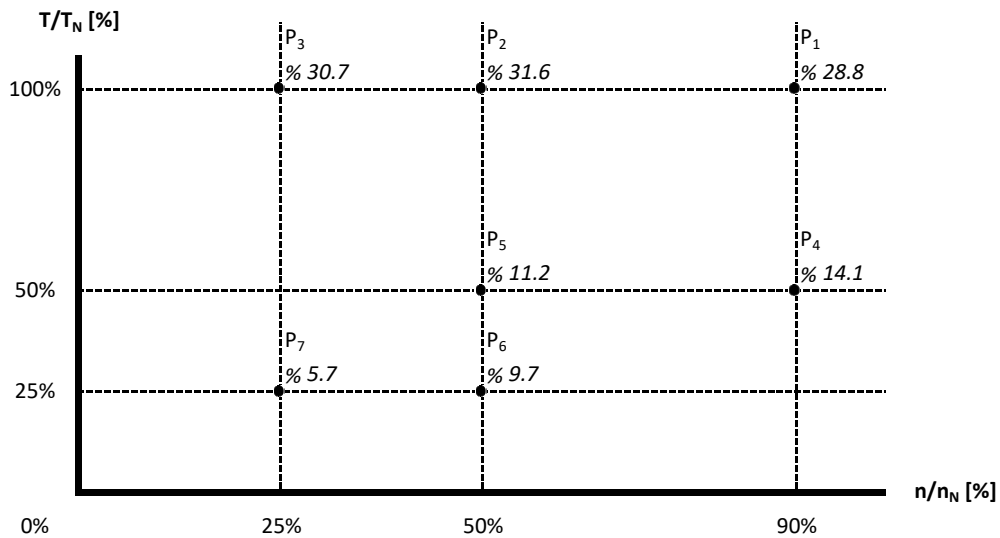

Manufactured and tested in accordance with IEC 60034

FR.AG.010 REV.NO: 04 REV.DATE: 01.01.2023

*Technical data are subject to change! There may be discrepancies between calculated and rating plate values.

*ELK Motor has right to change all the data without prior notice.

Motor Code : 2EL071M2B-FA-A0-000

Torque and Current Curves Related to Speed

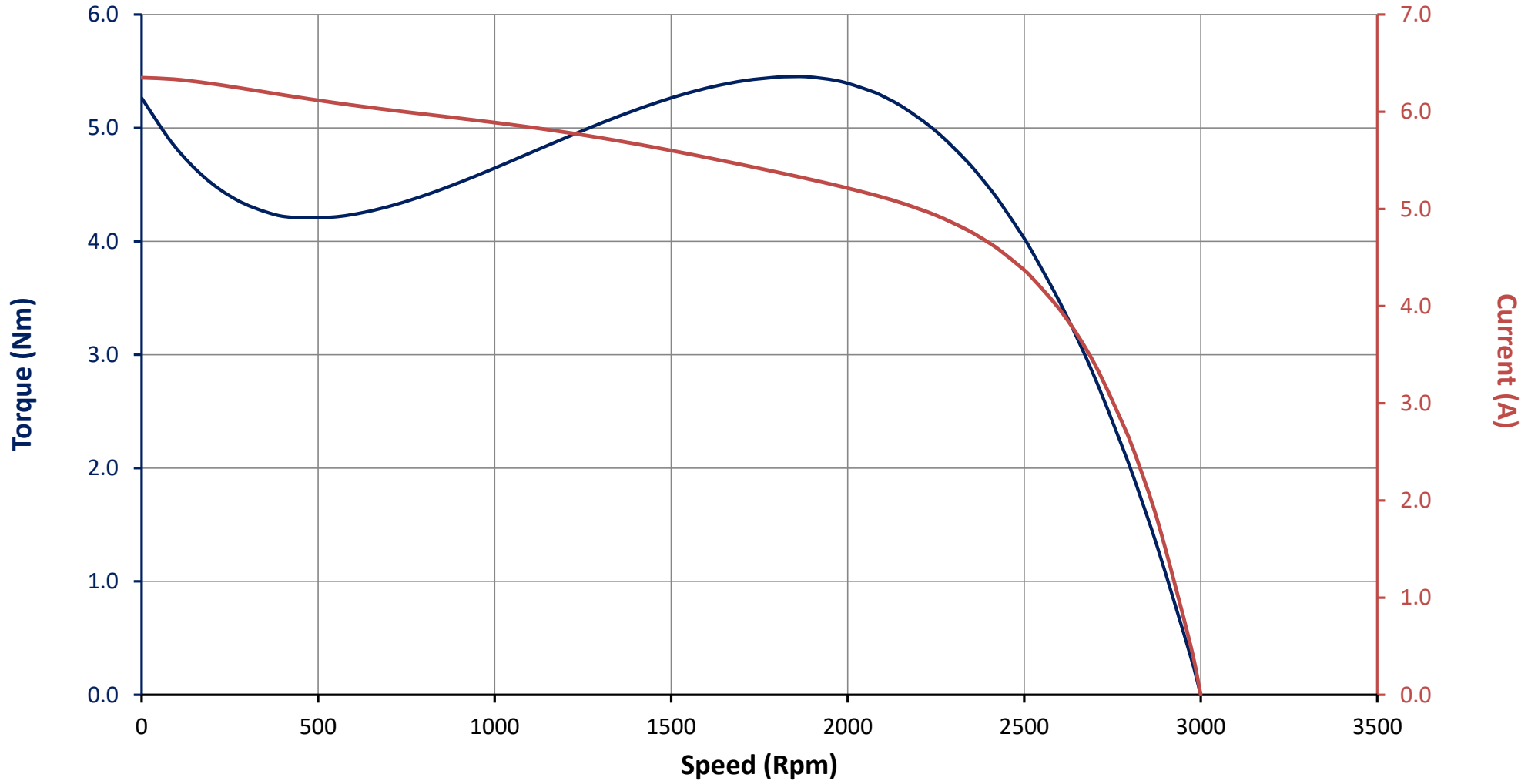

Motor Code : 2EL071M2B-FA-A0-000

Performance Curves Related to Rated Output

